

765 / &7
765 / &7)

7UHQFK 026 %DUULHU 6FKRWWN\ 5H

72 \$%
765 / &7

,72 \$%
765 / &7)

)HDWXUHV

‡ \$GYDQWUHQFK WHFKQRORJ\
‡ /RZRUZDURGDWDJH GURS
‡ /RZRZURVVHV
‡ +LJHILFLHQF\ RSHUDWLRO
‡ /HDGH)HLQLVK &RPSOLDQW

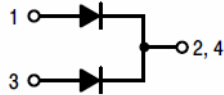
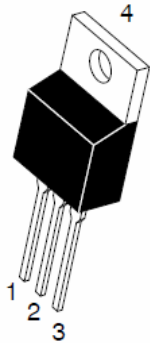

\$SSOLFDWLROV

‡ '& '& &RQYHUWHUV
‡ \$& '\$GDSWRUV
‡ 6ZLWFKRZHXSSOLHV
‡)UHHZKHHLRGGHJ

0D[LPXP UDWLQJV DQG HOHFWULFDJ& FXODDPRVHUQRVWHIGF V

3DUDPHWHU		6\PERO	/LPLW	8QLW
0D[LPXP SHSHVSHUNYHYURQHW DJH		9550		9
0D[LPXPYHURJHZDUG UFXEWHIHWG	GHYLFH SHGLRGH	,) \$9		\$
3HDN IRVZDURBUHQW VLQDQH ZDYH VXSHULPSRVHGRFSGUDRCHG		,)60		\$
2SHUDMXQRDQWRUDJH WHPSHUDW	XUHURDJH	WR		f&
7\SLFVCHUPDO USHVULVQHDQFH	72 \$% ,72 \$%	5\$-&		f& : f& :
,QVWDQWDQHRROWRUJZDUG SHGLRGH		9)	7<3	0\$;
	,) 3\$		7-	f&
	,) 3\$		7-	f&
	,) \$		7-	f&
,QVWDQWDQHRXUUSHVHURQHW UDWHYHYURQHW DJH		,5		X\$ P\$
			7-	f&

1RWHV

3XOVH WHVWSXOVH ZLGWK GXW\FFOH

3XOVH WHVW 3XOVH ZLGWK 0 PV

5 \$ 7, 1 * 6 \$ 1' & + \$ 5 \$ & 7 (5, 6 7, & 6 & 7 8 5 9 (6 f & X Q O H V Q R W K B U Z L V H

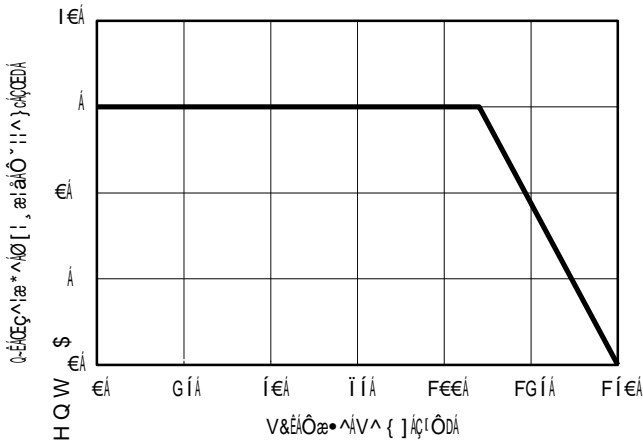

Figure 1: Current Derating, Case

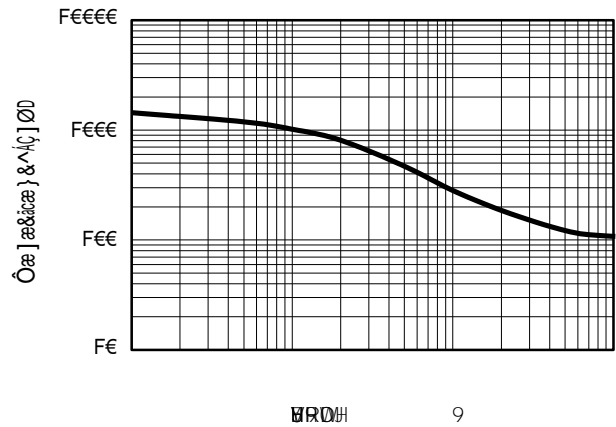
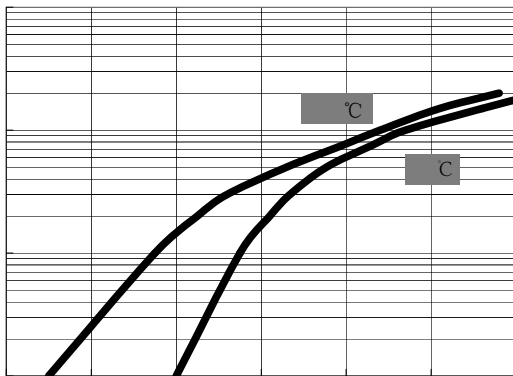

Figure 2: Typical Junction Capacitance



)RUZDUG 9ROWDJH 9

)LJXUH

)RUZDUG & XUHHQW

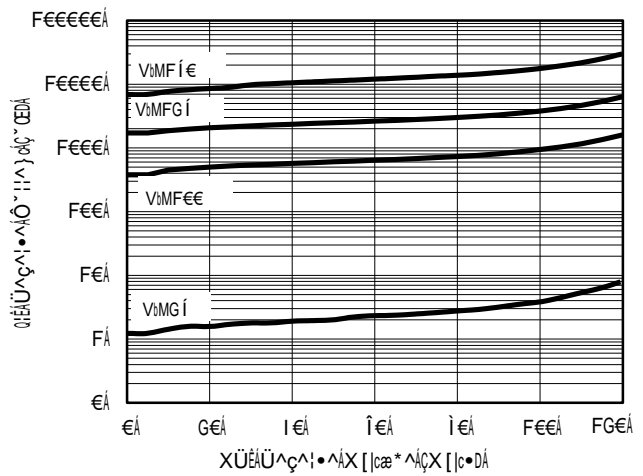
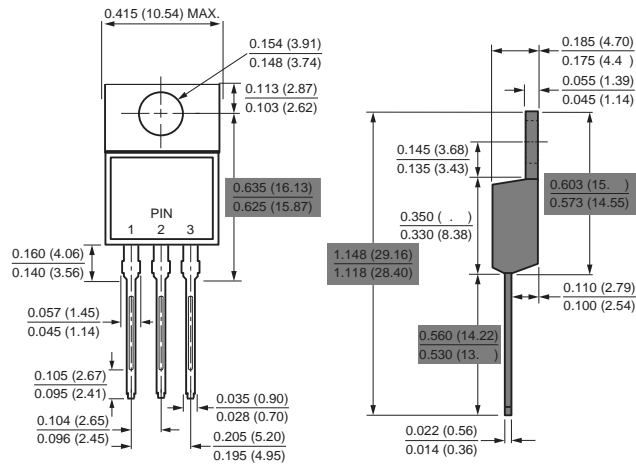

Figure 4: Typical Reverse Current

3 \$ & . \$ * (287 / , 1 (' , 0 (16 , 2 1 6
1 R W H X Q L W , Q P P

TO-220AB



ITO-220AB

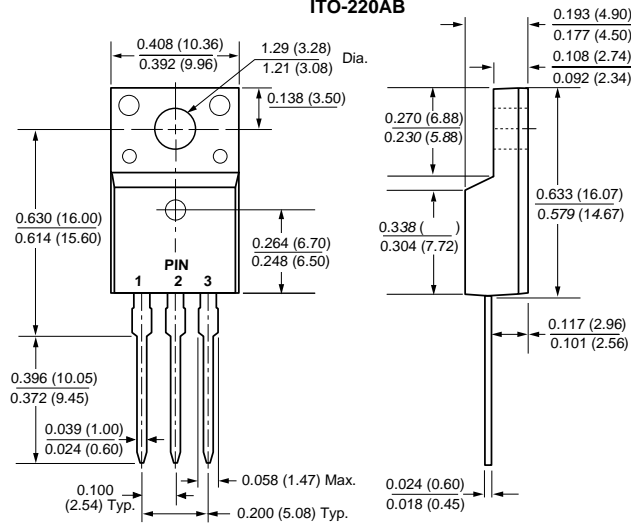

0DUNLQJ ,QIRUPDWLRQ

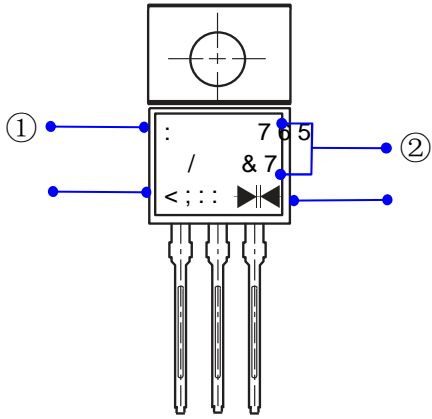

- ①
- ② 3URGXFW 765 & 7)
- ③ 3' & LQIRUPDWLRQ

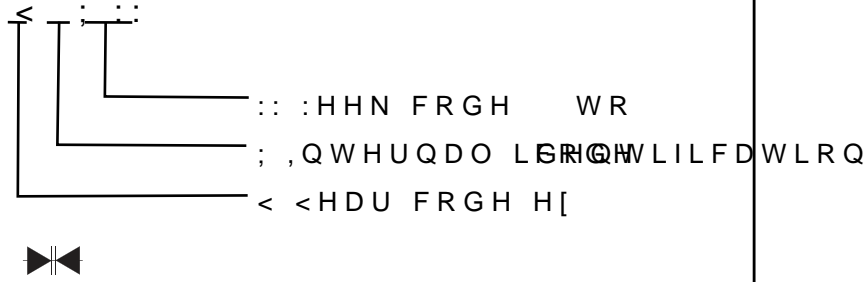

3DFNDJLQJ ,QIRUPDWLRQ

7XEH 'LPHQVLRQV

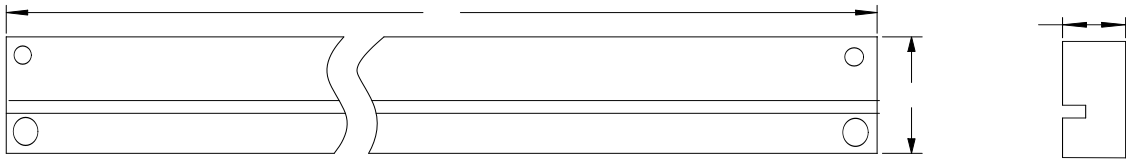

,QVLGH %R[

2XWVLGH %R[

3DFNDJLQJ ,QIRUPDWLRQ

12	81,	7XEH 'LPHQVLRQV			,QVLGH %R[2XWVLGH %R[
6L]H	PP	\$	%	&	/	:	+	/	:	+
47<	3&6	3&6 7XEH			6PDO SHFWDJH3&6 WXE'WRWDO			3&6 FDUERGLWRWDO		
1RWH		7ROHUDQFH PP" PP			PP" PP			PP" PP		