

2 6 % D U U L H U 6 F K R W W N

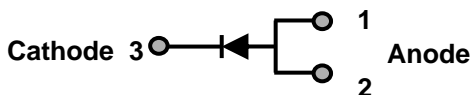

TO-277



Features

- Advanced trench technology
- Low forward voltage drop
- Low power losses
- High efficiency operation
- Lead Free Finish, RoHS Compliant

Applications

- DC/DC Converters
- AC/DC Adaptors
- Switching Power Supplies
- Freewheeling Diodes

Maximum ratings and electrical characteristics (TJ = 25°C unless otherwise noted)

Parameter		Symbol	Limit		Unit	
Maximum repetitive peak reverse voltage		VRRM	0		V	
Maximum average forward rectified current		IF(AV)			A	
Peak forward surge current 8.3 ms single half sine- wave superimposed on rated load per diode		IFSM			A	
Operating junction and storage temperature range		TJ, TSTG	- to +150		°C	
7 \ S L F D O W K H U P D O U H V L V W D Q F H S H I R J C L R G H O R X Q W H G R C) C W 3 & %						
Instantaneous forward voltage per diode		VF(1)	TYP.	MAX.	V	
	IF=2A		TJ=25°C	0.56		0.61
	IF=2A		TJ=125°C	0.50		-
	IF= A		7 - &	0.71		0.78
Instantaneous reverse current per diode at rated reverse voltage	TJ=25°C	IR(2)	5	50	uA	
	TJ=125°C		5	-	mA	

Notes:

- (1) Pulse test: 300 μs pulse width, 1 % duty cycle
- (2) Pulse test: Pulse width 0 40 ms

RATINGS AND CHARACTERISTICS CURVES

7\$ f & XQOHV\QRWKB UZLVH

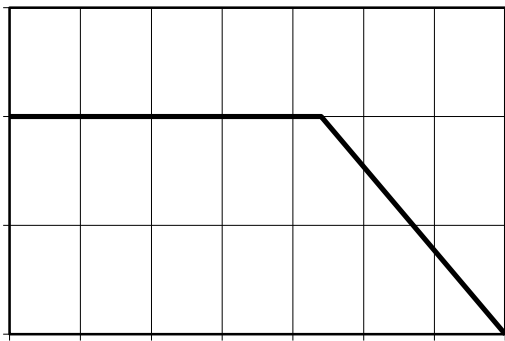

7F & DVH 7HPS

μCE v š OE š]vPU

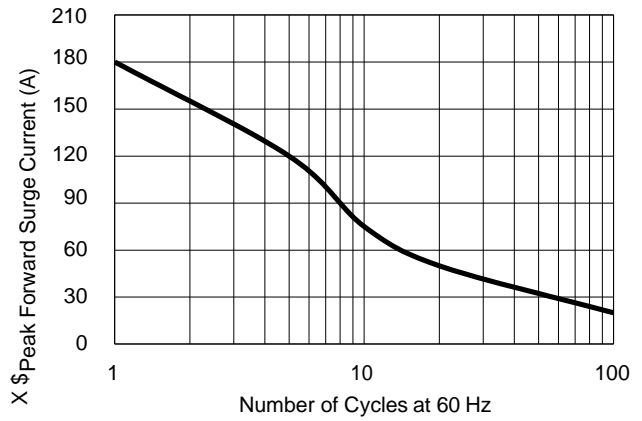

X\$Peak Forward Surge Current (A) AE]uμu Z % š]š]À ^μCEP μCECE

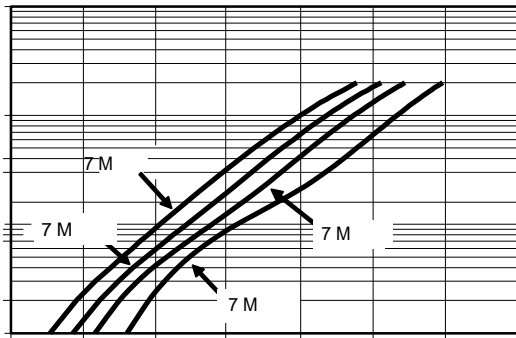

91 , QVWDQWDQ HFRXOW)DRJH Z DRUG

dÇ%] o &}CEÁ CE s}oš P

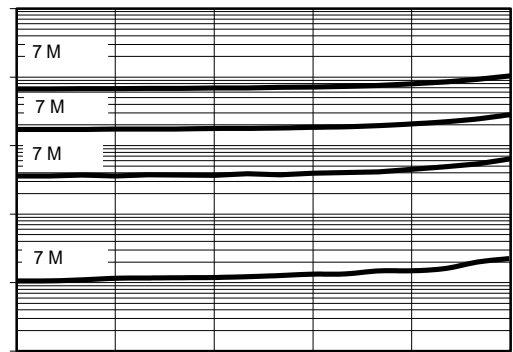

95 5HYHUVH 9ROWDJH 9ROWV

dÇ%] o Z À CE• μCECE v š

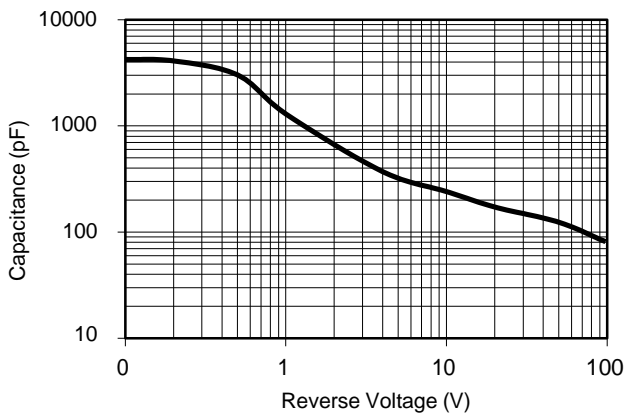

dÇ%] o :μv š]}v %]š v

PACKAGE OUTLINE DIMENSIONS

7 2

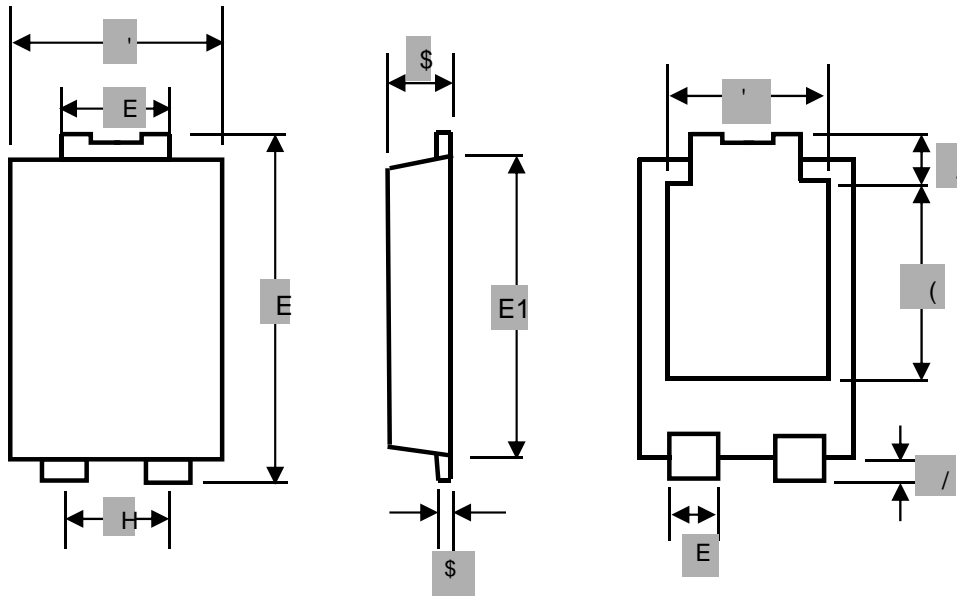

7 2 P H F K D Q L F D O G D W D

7 2 **Suggested Pad Layout**

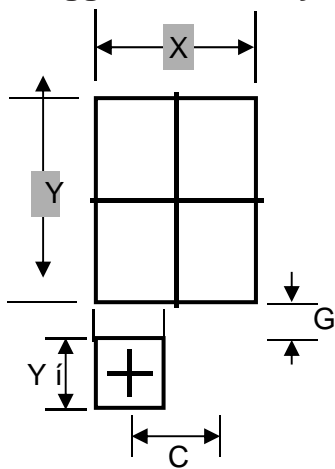

8 1 , 7		&	*	;	;	
PP	PLQ					
PLO	PLQ					

Marking Information

7 Product model : 7 6 3 9 6 3 5 H I H U U H G
W R D V 9

8 PDC information Æ

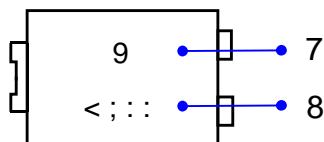

Y X WW

WW:Week code(01 to 53)

X:Internal identification code

Y:Year code(ex:0=2020)

Packaging Information

5 H H O ' L P H Q V L R Q V

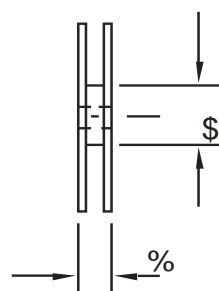
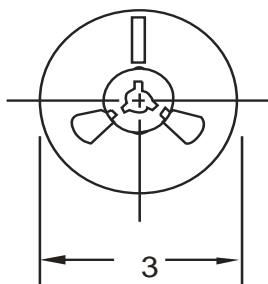

, Q V L G H % R [

2 X W V L G H % R [

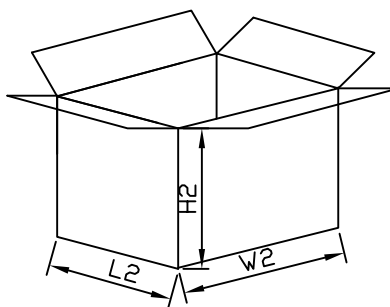
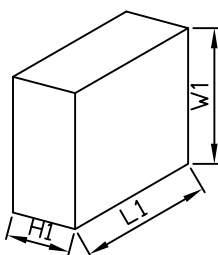

Packaging Information

1 2	8 1 ,	5 H H O ' L P H Q V L R			, Q V L G H % R [2 X W V L G H % R [
6 L] H	PP	&	\$	%	/	:	+	/	:	+
4 7 <	3 & 6	6 P D O O H V W S D F N D J H			3 & 6 U H H O			3 & 6 3 & 6 H F B O W R Q W R W D O		
1 R W H		7 R O H U D Q F H P " P P			P P " P P			P P " P P		