

7UHQFK 026 %DUULHU 6FKRWWN\ 5H

Features

- ‡ \$GYDQWUHQFK WHFKQRORJ\
- ‡ /RZRUZDURGDWDJH GURS
- ‡ /RZRZURVVHV
- ‡ +LJHILFLHQF\ RSHUDWLRO
- ‡ /HDGH)HLQLVK &R#6OLDQW

763 / \$)

SMAF



&DWKRGH \$QRGH

Applications

- ‡ '&' &RQYHUWHUV
- ‡ \$&'&GDSWRUV
- ‡ 6ZLWFKRZHXSSOLHV
- ‡)UHHZKH'HLRQJ

Maximum ratings and electrical characteristics (TJ = 25°C unless otherwise noted)

3DUDPHWHU		6\PERO	/LPLW	8QLW
0D[LPXLFHSHVSHUNYHYURQHW DJH		9550		9
0D[LPXDPYHURDJH ZDUG UFXEWHIQWG		,) \$9		\$
3HDN IRVZDURSUHQW VLQDQH ZDYH VXSHULPSRVHGRFSGURVGHG		,)60		\$
2SHUDMXQRVLRQWRUDJH WHPSHUDW		X0H 060JH	WR	f&
7\SLFDO WKHUPDO UHVLVWDQFH SHU ORXQWHG RQ)5 3&%		GLRGH 5\$-&		f& :
,QVWDQWDQHRXV IRUZDUG YROWDJH	,) \$	7- f&	7 < 3	9
	,) \$	7- f&	0\$;	
	,) \$	7- f&		
	,) \$	7- f&		
,QVWDQWDQHRXV UHVRUQWH UDWHYHYURQHW DJH		7- f&		X\$
		7- f&		P\$

1RWHV

3XOVH WHVVSXOVH ZLGWK GXW\F\FOH

3XOVH WHVW 3XOPH ZLGWK 0

TSP5L60AF

19-NOV-2018

RATINGS AND CHARACTERISTICS CURVES

f & X Q O H V Q R W K G U Z L V H

I, S Y H U D R H U Z D L X G J U H S Q W

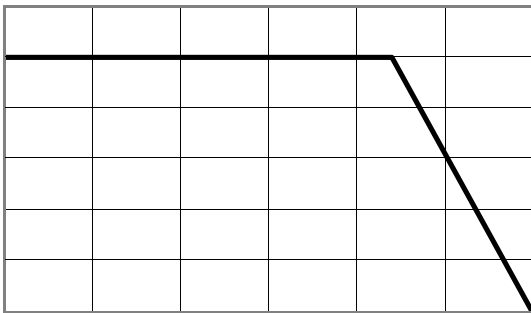

7 F & D V H P S &

Current Derating, Case

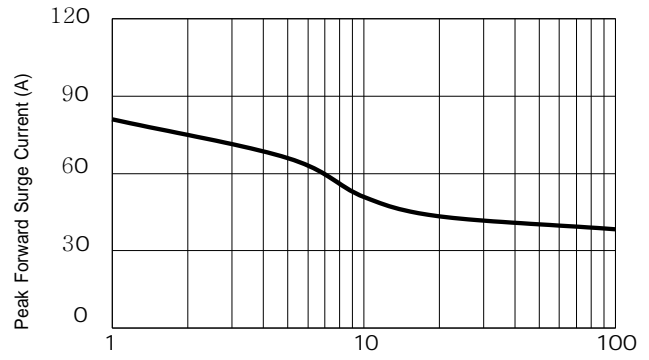

1 X P E R U & \ D W H + V

Maximum Repetitive Surge Current

I, Q V W D Q W J P R O U Z B L X G J U H S Q W

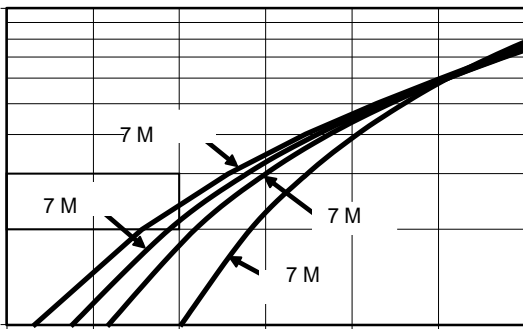

9 I , Q V W D Q W D Q H S R K O W D R J Z D B G

Typical Forward Voltage

I, U S H Y H L & X H U U H K S W

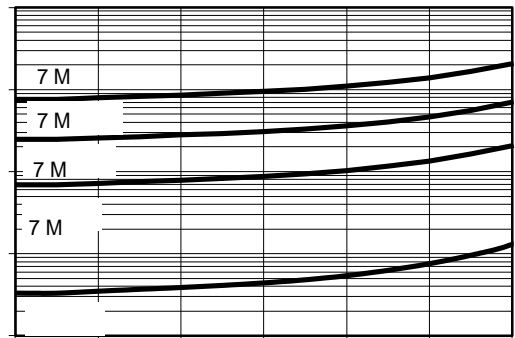

9 5 5 H Y H U V H 9 R O W D J H 9 R O W V

Typical Reverse Current

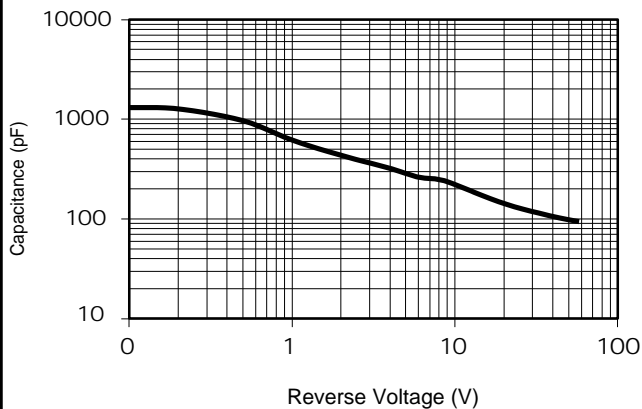

Typical Junction Capacitance

PACKAGE OUTLINE DIMENSIONS

60 \$)

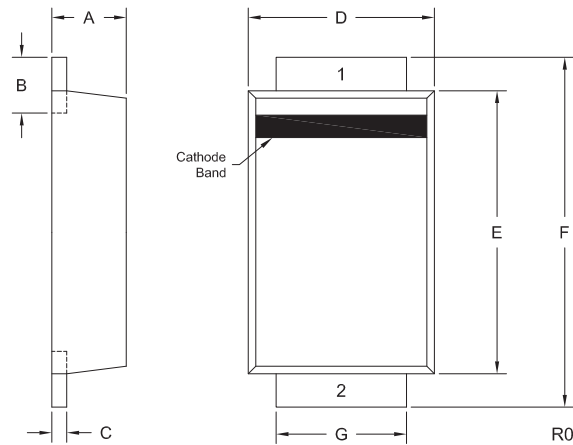

SMAF mechanical data

UNIT		A	B	C	D	E	F	G
mm	max	1.10	0.95	0.25	2.8	3.9	4.9	1.65
	min	0.85	0.50	0.11	2.2	3.2	4.2	1.20
mil	max	43.30	37.40	9.84	110.24	153.54	192.91	64.96
	min	33.46	19.68	4.33	86.61	125.98	165.35	47.24

60 \$) 6 X J J H V W D H G \ R X W

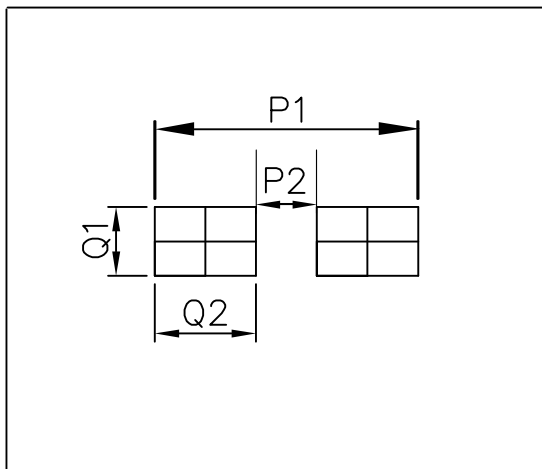

81,7		3	3	4	4
PP	PLQ				
PLQ	PLQ				

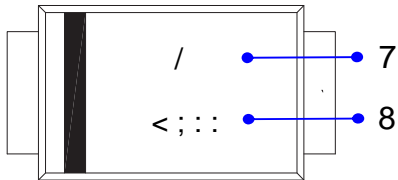

3URGXFW 763GH\$) LV DEEUHYLDWHG V
83' & LQIRUFDWLRQ

< ; ::

:: :HHN FRGH WR
; ,QWHUQDO LGHQWLILFDWLRQ
< <H DU FRGH H[

3DFNDJLQJ ,QIRUPDWLRQ

5HHO 'LPHQVLRQV

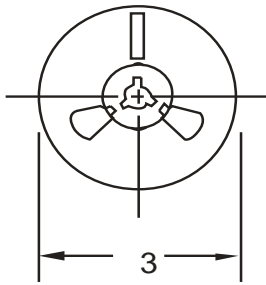

,QVLGH %R[

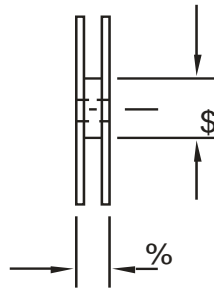

2XWVLGH %R[

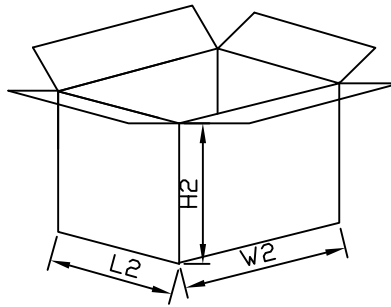
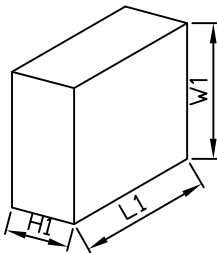

3DFNDJLQJ ,QIRUPDWLRQ

12	81,	5HHO 'LPHQVLRQ			,QVLGH %R[2XWVLGH %R[
6L]H	PP	&	\$	%	/	:	+	/	:	+
47<	3&6	6PDO SHFWDJH			3&6 UHHO3&6 UHWDWDO			3&6 FDUWRQ QRFWD		
1RWH		7ROHUDQFPP" PP			PP" PP			PP" PP		