

7 U H Q F K 0 2 6 % D U U L H U 6 F K R W W N \ 5 H

Features

- Advanced trench technology
- Low forward voltage drop
- Low power losses
- High efficiency operation
- Lead Free Finish, RoHS Compliant

Applications

- DC/DC Converters
- AC/DC Adaptors
- Switching Power Supplies
- Freewheeling Diodes

Maximum ratings and electrical characteristics (TJ = 25°C unless otherwise noted)

Parameter	Symbol	Limit	Unit
Maximum repetitive peak reverse voltage	VRRM		V
Maximum average forward rectified current	IF(AV)		A
Peak forward surge current 8.3 ms single half sine- wave superimposed on rated load per diode	IFSM	60	A
Operating junction and storage temperature range	TJ, TSTG	WR	°C
7 \ S L F D O W K H U P D O U H V L V W D Q F H S H U G L S G H 0 R X Q W H G R Q) 5 3 & C A V			
Instantaneous forward voltage per diode	VF(1)	7 < 3	0 \$;
		IF= A	TJ=25°C
		IF= A	TJ=125°C
Instantaneous reverse current per diode at rated reverse voltage	IR(2)	TJ=25°C	X \$
		TJ=125°C	mA

Notes:

3 X O V H W H V W 3 X O V H Z L G W K G X W \ F \ F O H
 3 X O V H W H V W 3 X O P W H Z L G W K 0

RATINGS AND CHARACTERISTICS CURVES (TA = 25 C unless otherwise noted)

If, Average Forward Current(A)

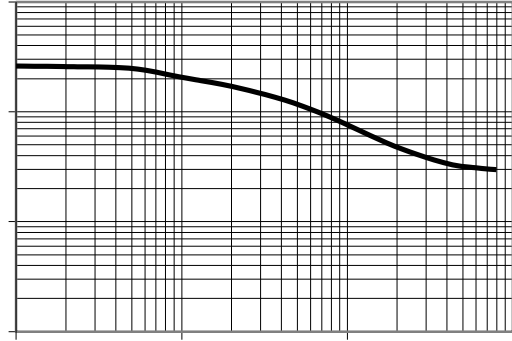
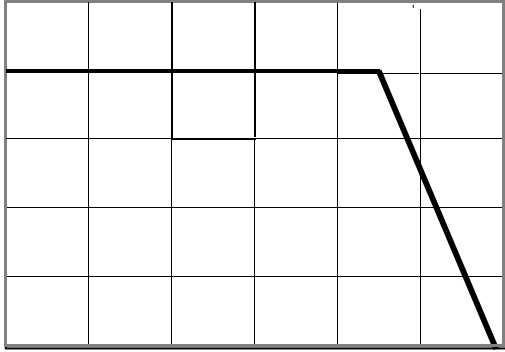

If, Instantaneous Forward Current (A)

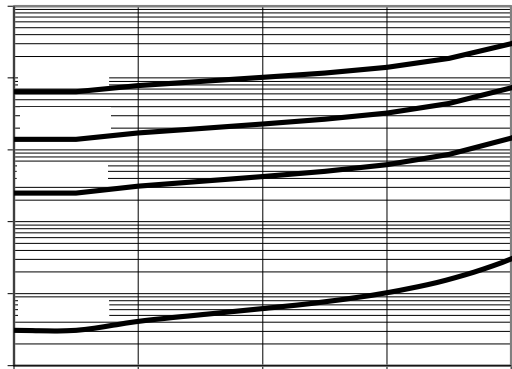
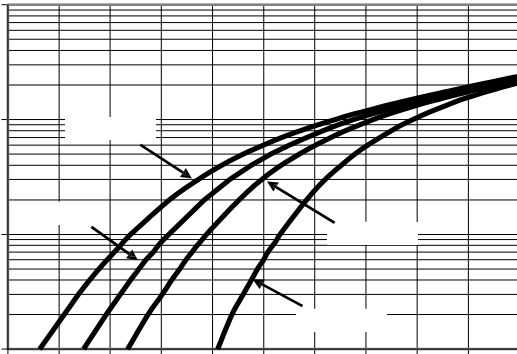

PACKAGE OUTLINE DIMENSIONS

TO-277

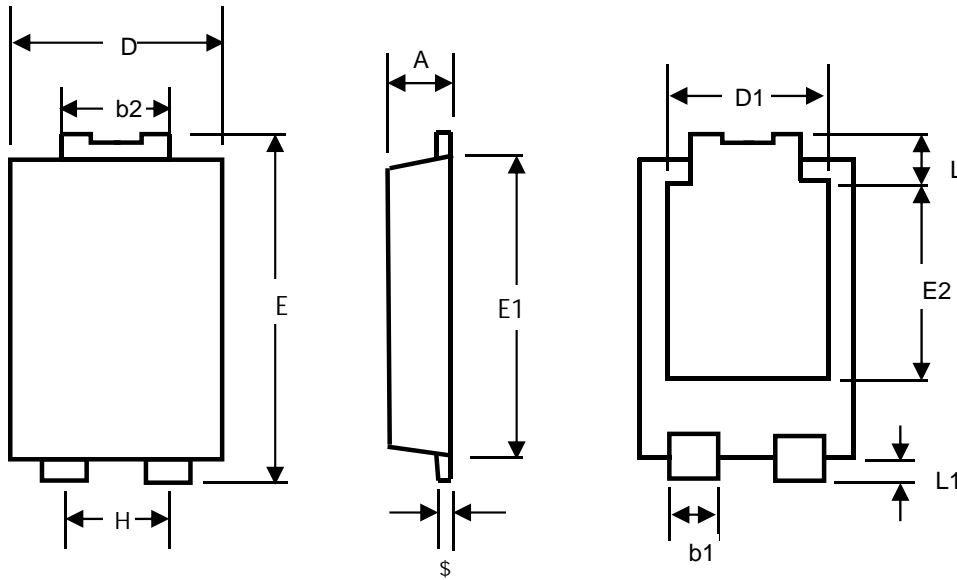

TO-277 Mechanical Data

UNIT	A	A2	b1	b2	D	D1	E	E1
------	---	----	----	----	---	----	---	----

TO-277 Suggested Pad Layout

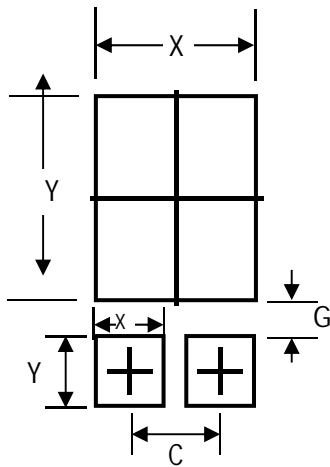

UNIT		C	G	X	X1	Y	Y1
mm	min	1.80	0.90	3.4	1.4	4.9	1.4
mil	min	78.86	35.43	133.86	35.43	192.91	55.12

Marking Information

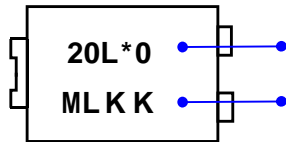

Product model :TSP20L60SP

Referred to as 20L60

PDC information

Y X WW

WW:Week code(01 to 53)

X:Internal identification code

Y:Year code(ex:0=2020)

Packaging Information

1.Reel Dimensions

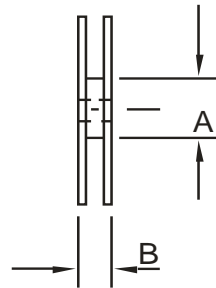
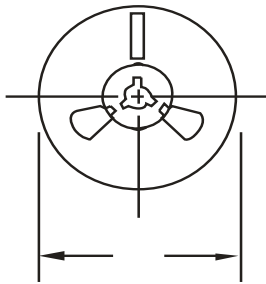

2. Inside Box

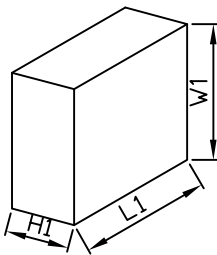

3. Outside Box

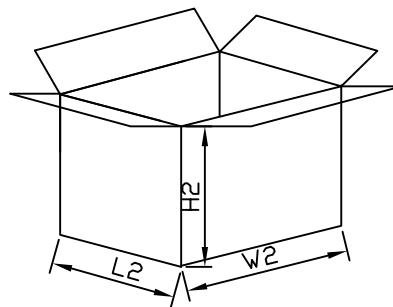

Packaging Information

NO	UNIT	Reel Dimensions			Inside Box			Outside Box		
			A	B	L1	W1	H1	L2	W2	H2
Size	mm	330	70	15	335	335	43	360	360	360
QTY	PCS	Smallest package,5000PCS/reel			10,000PCS,2 reel in total			80,000PCS/carton,8 boxes in total		
Note	Tolerance 20mm,±3mm; 21-100mm,±5mm; 101-500mm,±10mm									