

7UHQFK 026 %DUULHU 6FKRWWN\ 5H

Features

- ‡ \$GYDQWUHQFK WHFKQRORJ\
- ‡ /RZRUZDURQWDJH GURS
- ‡ /RZRZURVVHV
- ‡ +LJHILFLHQF\ RSHUDWLRO
- ‡ /HDGHLQLVK &RPSOLDQW

763 / \$)

SMAF

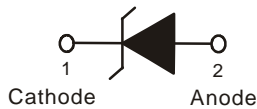

Applications

- ‡ '&' & RQYHUWHUV
- ‡ \$&' & GDSWRUV
- ‡ 6ZLWFKRZHXSSOLHV
- ‡)UHHZKHHLQGHV

Maximum ratings and electrical characteristics (T_J = 25°C unless otherwise noted)

3DUDPHWHU		6\PERO	/LPLW	8QLW
0D[LPLXPHSHVSHUNYHYURQWDJH		9550		9
0D[LPLXPHYHURJHZDUG UFXEWHIQWG		,) \$9		\$
3HDN IRVZDURSUUHQW VLQDQHQH ZDYH VXSHULPSRVHGRFSDURVGHG		,)60		\$
2SHUDMXQDQURQWRUDJH WHPSHUDW		X0H 060JH	WR	f&
7\SLFDO WKHUPDO UHVLVWDQFH SHU ORXQWHG RQ)5 3&%		GLRGH 5\$-&		f& :
,QVWDQWDQHRXV IRUZDURQWDJH		9)	7<3	0\$;
	,) \$		7- f&	
,QVWDQWDQHRXV UHVLVWDQFH UDWHYHYURQWDJH		,5		X\$
			7- f&	

1RWHV

3XOVH WHVVSXOVH ZLGWK GXW\F\FOH

3XOVH WHVW 3XOVH ZLGWK 0

RATINGS AND CHARACTERISTICS CURVES

7 \$

f & X Q O H V Q R W K B U Z L V H

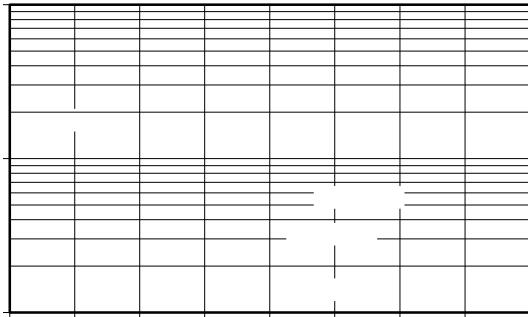
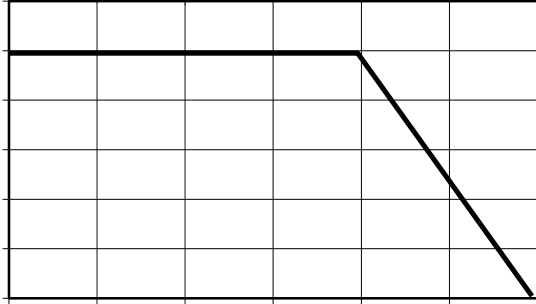

ODUNLQJ ,QIRUPDWLRQ

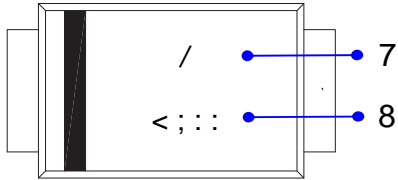

73URGXFW PRGHO \$) LV DEEUHYLDW
83' & LQIRUPDWLRQ

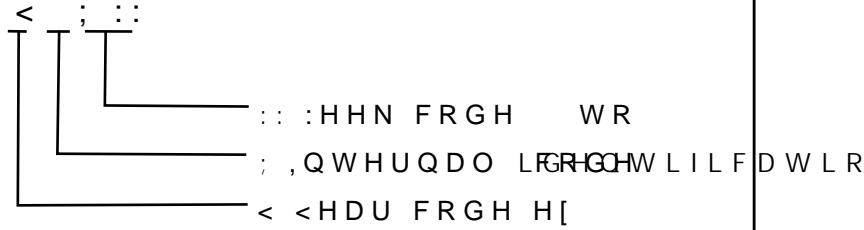

3DFNDJLQJ ,QIRUPDWLRQ

5HHO 'LPHQVLRQV

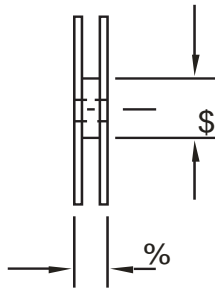
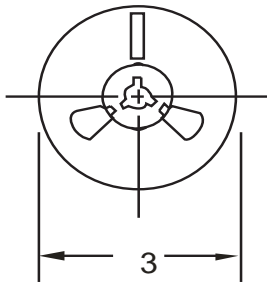

,QVLGH %R[

2XWVLGH %R[

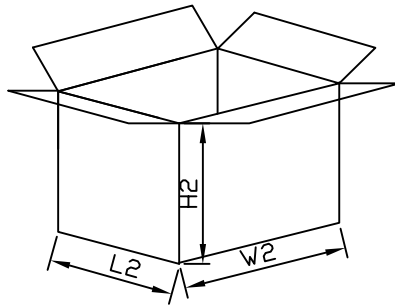
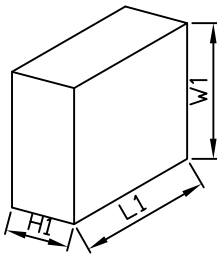

3DFNDJLQJ ,QIRUPDWLRQ

12	81,	5HHO 'LPHQVL	,QVLGRH[2XWVLGH %R[
----	-----	--------------	----------	-------------

& \$ % / : + / : +

6L]H PP

4 — -iGd 3Ó4 4Gd 7C yvAc3-4 @ á G@C@C@CH %3>iü#.<# 308@52E@WDY#4 |GPe1s G\$Ö.#0`k#<12CAvUP`>á