

7 UHQFK 026 %DUULHU 6FKRWWN\ 5H

d^Wîi>òì
!"

Features

- ‡ \$GYDQWUHQFK WHFKQRORJ\
- ‡ /RZRZUZYRQWDJH GURS
- ‡ /RZRZUZYRQVHV
- ‡ +LJHILFLHQF\ RSHUDWLRO
- ‡ /HDGH)HLQLVK &R#6OLDQW

ï

1

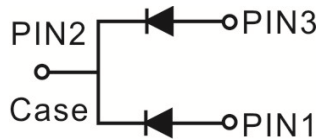

Applications

- ‡ '&' & RQYHUWHUV
- ‡ \$&' & \$GDSWRUV
- ‡ 6ZLWF&RQD&XSSOLHV
- ‡)UHHZKH'HL&GQJ

Maximum ratings and electrical characteristics (T_J = 25°C unless otherwise noted)

3DUDPHWHU		6\PERO	/LPLW	8QLW
0D[LPHSHVSHUNYHYURQWDJH		9550		9
0D[LPHYHURJHZDUG UFXEWHI&WG	GHYLFH	,) \$9		\$
	SHGLRGH			
3HDNIRVZDUEBUHQW VL&DQH ZDYH VXSHULPSRVHGRFSCGUDR&HG		,)60		\$
2SHUDMXQ&DQWRUDJH WHPSHUDW		XU767*QJH	WR	f&
7\SLF&CHUPDO USHVULV&DQFH		72	5\$-&	f& :
,QVWDQWDQHR&R&WRUJZDUG SHGLRGH		9)	7<3	9
	,) \$		0\$;	
	,) \$			
	,) \$			
,QVWDQWDQHR&XUUSH&R&D&H UDWHYHYURQWDJH	7- f&	,5		X\$
	7- f&			P\$

1RWHV

3XOVH WHV&XOVH ZLGWK GXW\F&FOH

3XOVH WHVW 3XOPH ZLGWK 0

RATINGS AND CHARACTERISTICS CURVES 7\$ f & X Q @ M K H Q Z L W H H G

3 32:(5',66,3\$7,21 :

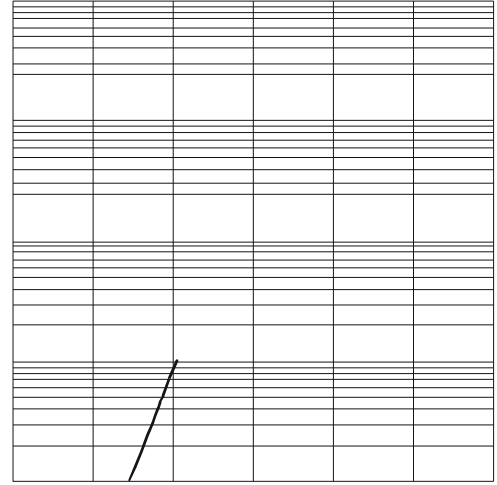
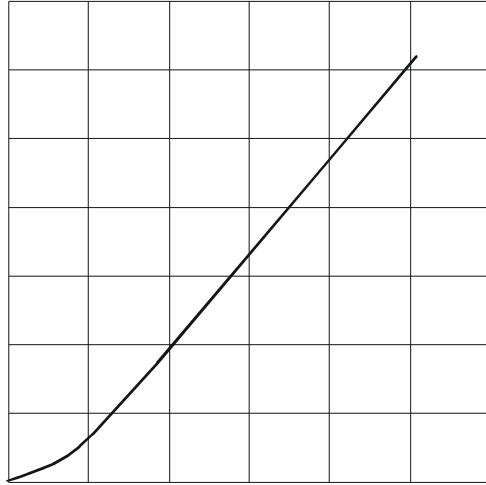

) \$9 \$9(5\$*()25:\$5' &855(17 \$
)LJXUH)RUZDUG 3RZHU 'LVVLSDWLRQ

PACKAGE OUTLINE DIMENSIONS

1 R W H X Q L W , Q P P

0DUNLQJ ,QIRUPDWLRQ

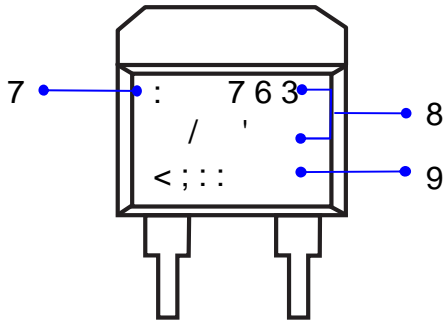

7 : &RPSDQ\ V WUDGHPDUN
8 3URGXFW PRGHO 763 / '
9 3'& LQIRUPDWLRQ

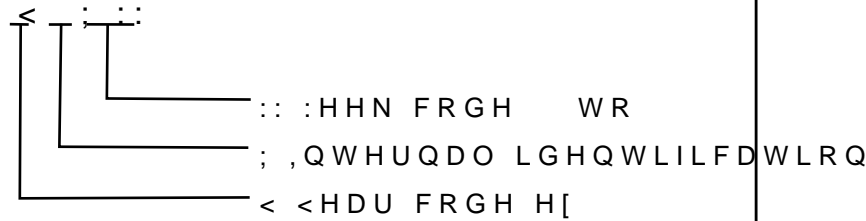

3DFNDJLQJ ,QIRUPDWLRQ

5HHO 'LPHQVLRQV

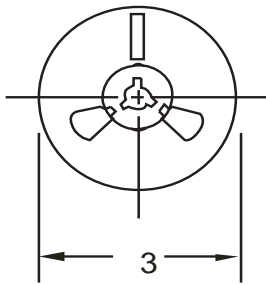

,QVLGH %R[

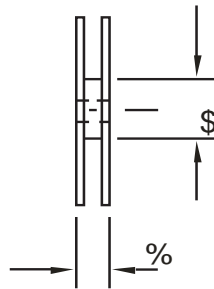

2XWVLGH %R[

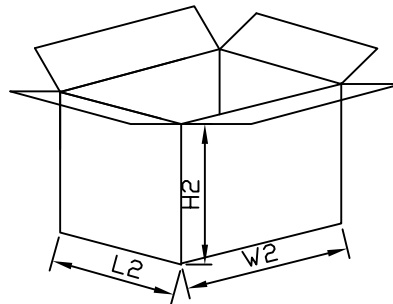
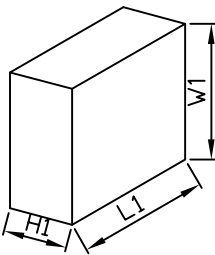

3DFNDJLQJ ,QIRUPDWLRQ

12	81,7	5HHO 'LPHQVLRQV			,QVLGH %R[2XWVLGH %R[
6L]H	PP	&	\$	%	/	:	+	/	:	+
47<	3&6 6PDO	SHVWDJH	3&6 UHHO	3&6 UHHO	WRWDO	3&6 FDU	WRWDO	WRWDO	WRWDO	WRWDO
1RWH		7ROHUDQFH PP" PP			PP" PP			PP" PP		