

--	--	--	--	--	--

Features

- Advanced trench technology
- Low forward voltage drop
- Low power losses
- High efficiency operation
- Lead Free Finish, RoHS Compliant

Applications

- DC/DC Converters
- AC/DC Adaptors
- Switching Power Supplies
- Freewheeling Diodes

Maximum ratings and electrical characteristics (TJ = 25°C unless otherwise noted)

Parameter	Symbol	Limit	Unit
-----------	--------	-------	------

Notes:

RATINGS AND CHARACTERISTICS CURVES

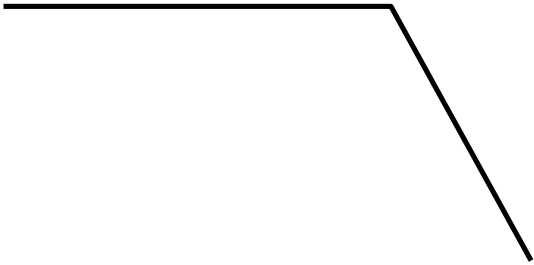

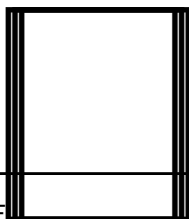

PACKAGE OUTLINE DIMENSIONS

SMAF

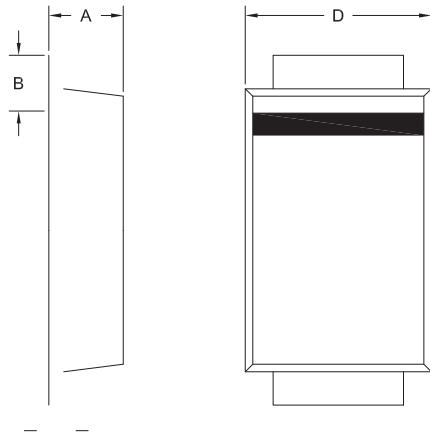

R0

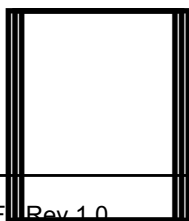



Marking Information

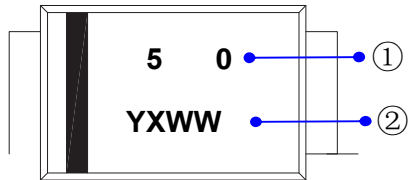

Product model : TSP5V100AF is abbreviated to 5 0

PDC information

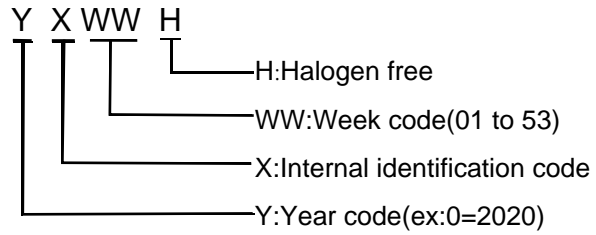

Packaging Information

1.Reel Dimensions

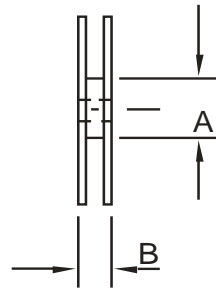
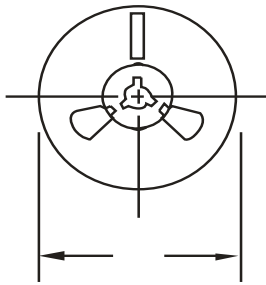

2.Inside Box

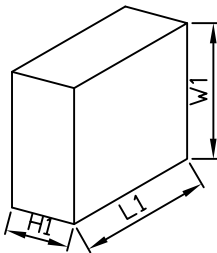

3.Outside Box

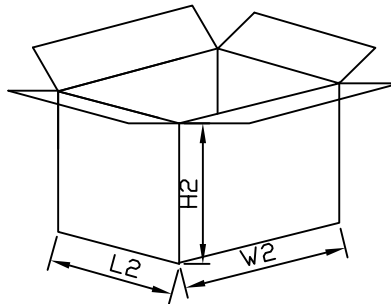

Packaging Information

NO	UNIT	Reel Dimensions			Inside Box			Outside Box		
			A	B	L1	W1	H1	L2	W2	H2
Size	mm	178	55	11	180	183	120	270	375	235
QTY	PCS	Smallest package,3000PCS/reel			30,000PCS,10reel in total			120,000PCS/carton,4boxes in total		
Note		Tolerance			20mm,±3mm;	21-100mm,±5mm;	101-500mm,±10mm			