

TO-220AB  
TSR 6 CT

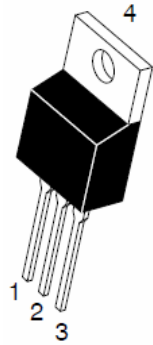

ITO-220AB  
TSR 6 CTF

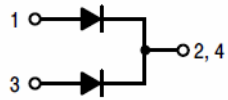
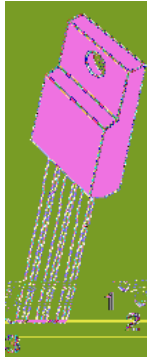

### Features

- ‡ \$GYDQWUHQFK WHFKQRORJ\
- ‡ /RZRUZDYGWDJH GURS
- ‡ /RZRZURVVHV
- ‡ +LJKILFLHQF\ RSHUDWLRO
- ‡ /HDGH)HLQLVK &R#6OLDQW

RATINGS AND CHARACTERISTICS CURVES 7\$ f & X Q O H V Q R W K B U Z L V H

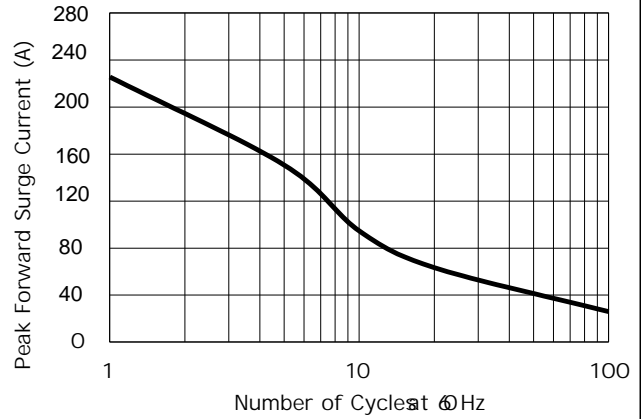
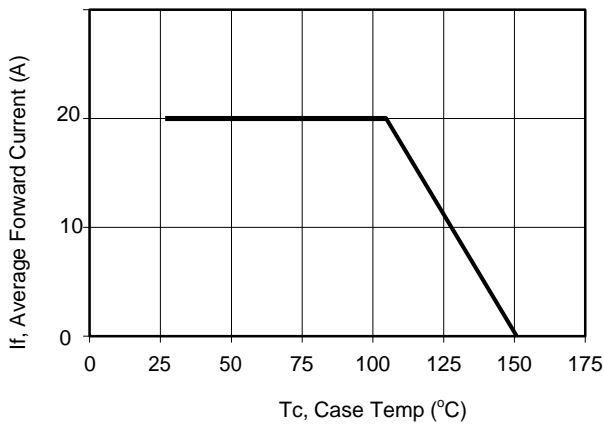

Current Derating, Case

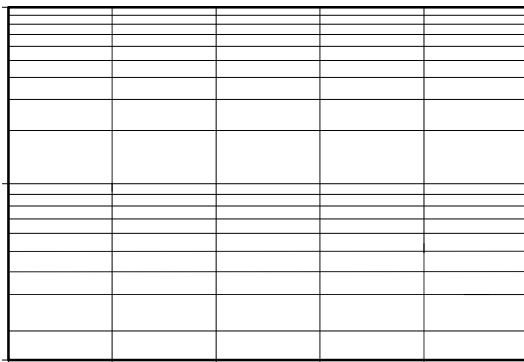

Maximum Repetitive Surge Current

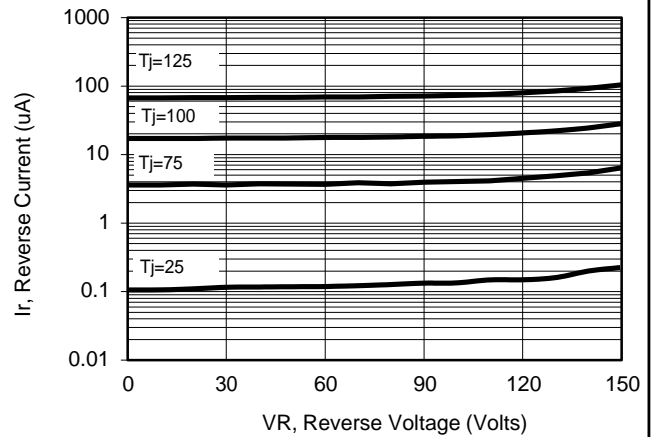

Typical Reverse Current

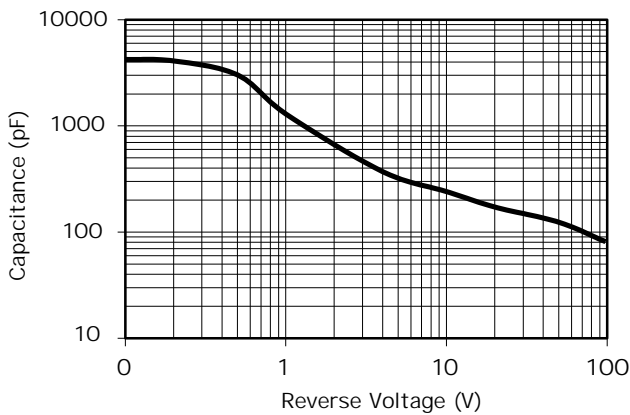

Typical Junction Capacitance

# PACKAGE OUTLINE DIMENSIONS

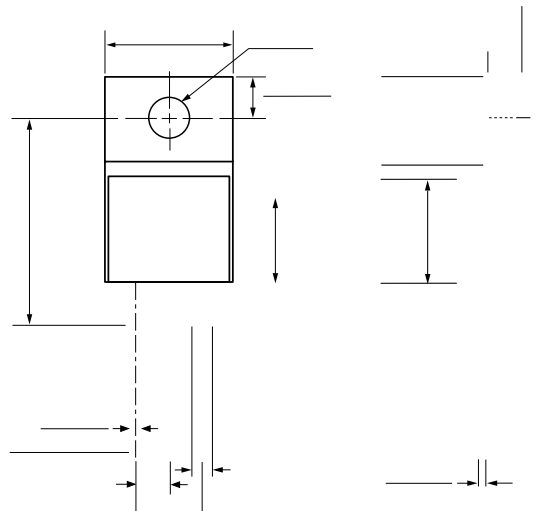

### Marking Information

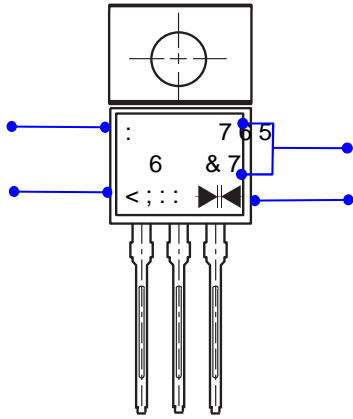

3 URGXFW 765GH60 & 7 RU 765 & 7)  
3' & LQIRUPDWLRQ

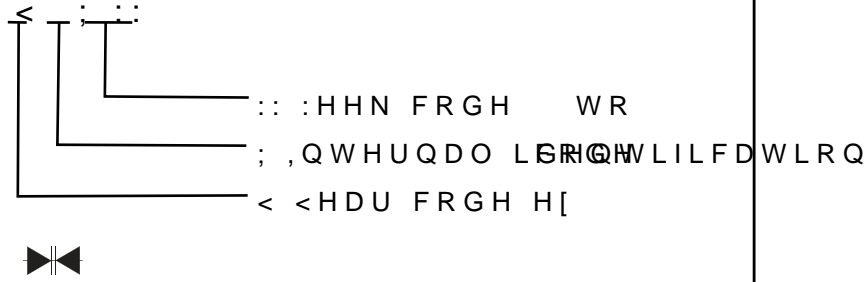

### Packaging Information

7XEH 'LPHQVLRQV

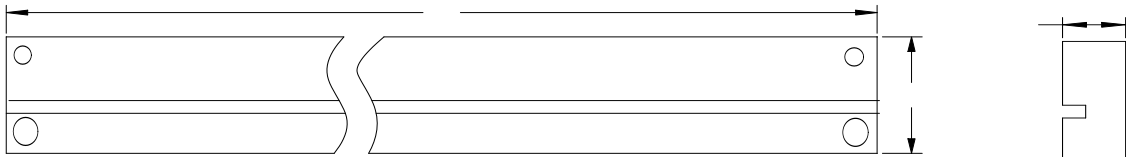

,QVLGH %R[

2XWVLGH %R[

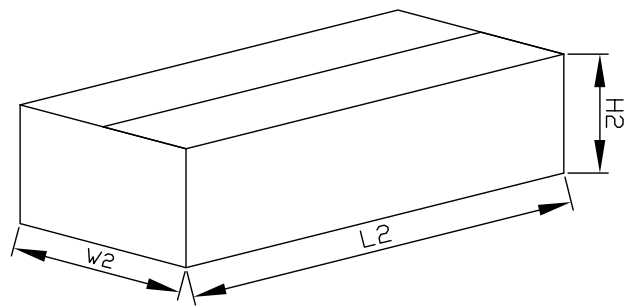
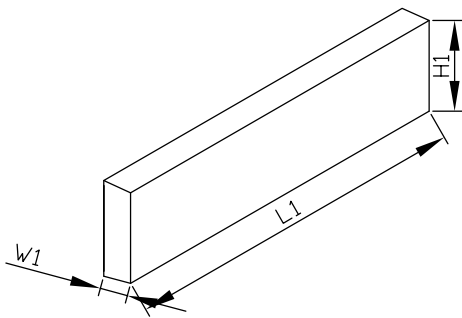

### Packaging Information

1 2	8 1 ,	7XEH 'LPHQVLRQV			,QVLGH %R[			2XWVLGH %R[		
6 L]H	PP	\$	%	&	/	:	+	/	:	+
4 7 <	3 & 6	3 & 6 7XEH			6PDO SHVWDJH3 & 6 WXEORWDO			3 & 6 FDUERQW LILFD WLRQ		
1 RW H		7ROHUDQFPP" PP			PP" PP			PP" PP		